

Assembling Your Valance

Parts

For All Types of Valances

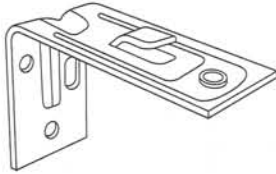

Valance Support Bracket
Quantity: 2 or more depending on size of valance

or

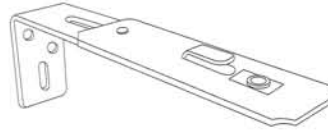

Valance Support Bracket
Quantity: 2 or more depending on size of valance

Standard Valance

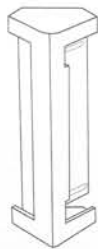

Corner Pieces
Quantity: 2

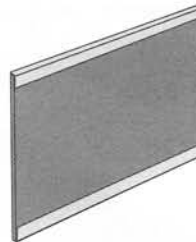

Valance Returns
Quantity: 2

Royal Valance

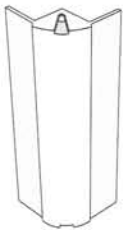

Corner Pieces
Quantity: 2



Corner Covers
Quantity: 4

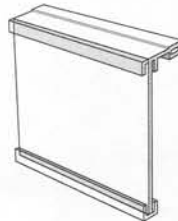

Valance Returns
Quantity: 2

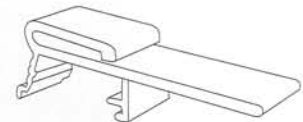

Valance Clips
Quantity: 2 or more depending on size of valance

Majestic Valance

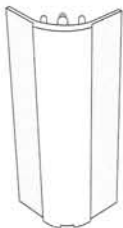

Corner Pieces
Quantity: 2, or 4 for Double Majestic Valance

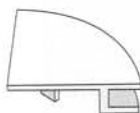

Corner Covers
Quantity: 4, or 6 for Double Majestic Valance



Valance Returns
Quantity: 2

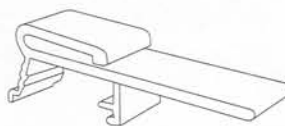

Valance Clips
Quantity: 2 or more depending on size of valance

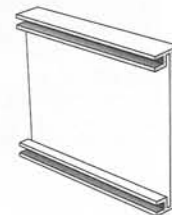

Lower Section Valance Returns
Quantity: 2

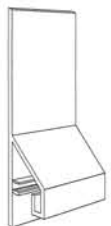

Lower Section Support Brackets
Quantity: 2 or more depending on size of valance

(only for Double Majestic Valance)

Step 1. Slide in valance insertion

Slide the valance insertion through the main valance section. **For a Double Majestic Valance, slide the valance insertion for both the main section and the lower section.**

Standard Valance

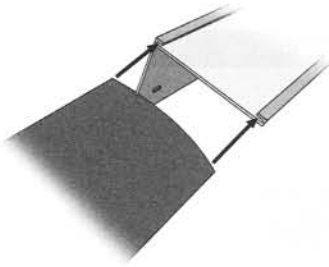

Royal Valance

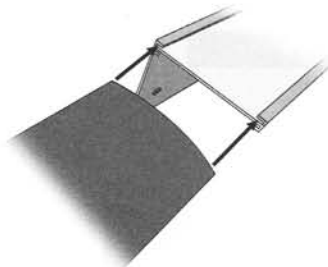

Majestic Valance

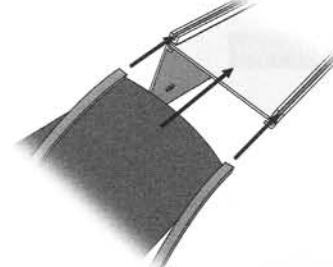

Note: If the material is too thick to slide in, pop the insertion into the main valance section. Take precaution not to break the material while bending the insertion.

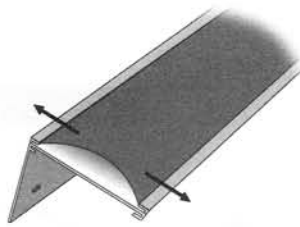

Step 2. Only for Double Majestic Valance: Attach the lower section

1. Slide all but two of the lower section support brackets into the main valance section and space them evenly (*Fig. A*).
2. Attach the lower section to the main section by sliding the lower section through the lower section support brackets (*Fig. B*).

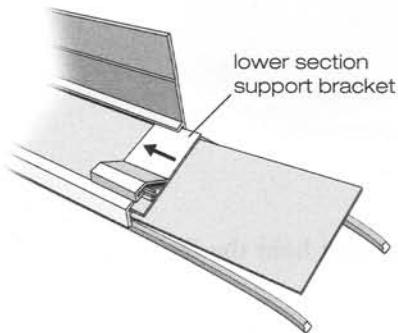

(Fig. A)

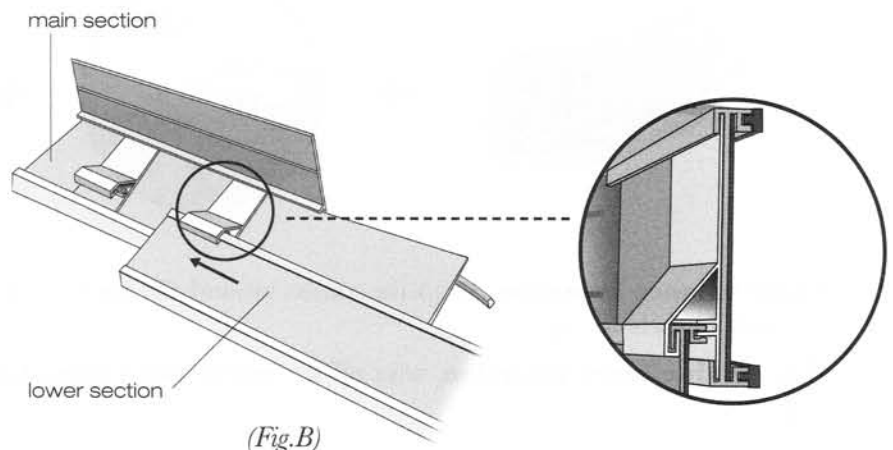

(Fig. B)

Step 3. Assemble the valance returns

Important for Double Majestic Valances: assemble the returns of the lower section **BEFORE** you assemble the returns of the main section.

1. Slide the corner pieces into the back slot of the main valance section.

Standard Valance

Royal Valance

Majestic Valance

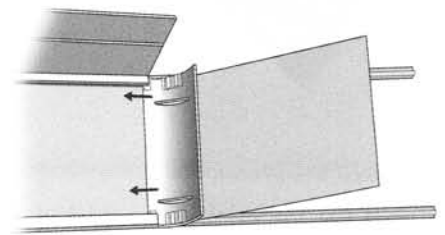
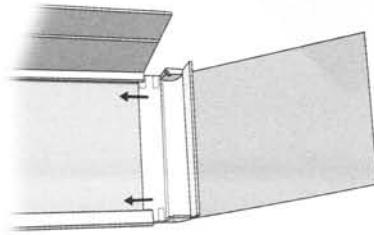
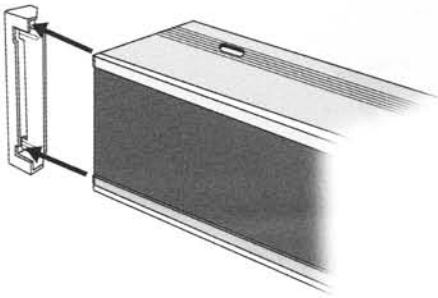

2. Insert the valance returns into the corner pieces.

Standard Valance

Royal Valance

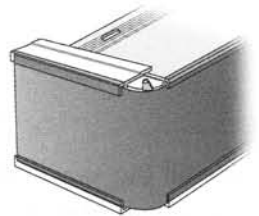
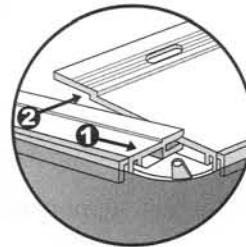
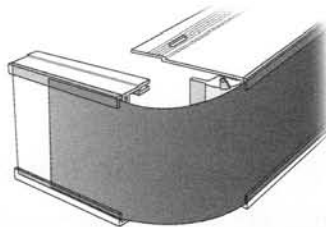
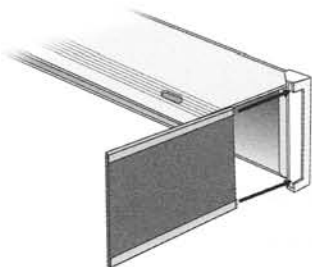

Majestic Valance

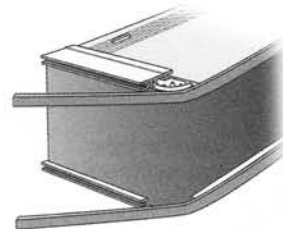
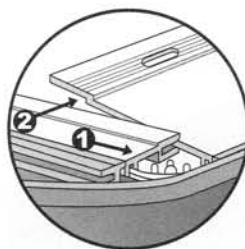
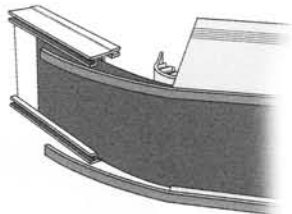

Note:

1. For **fabric valance insertion**, wrap the excess around the back of each return and hold the fabric insertion in place with household tape.
2. For **PVC or aluminum insertion**, trim off the excess with a utility knife by scoring the back of the insertion and snap it off.

3. Only for Royal and Majestic valance: Insert the four plastic top and bottom corners and push to secure entire valance.

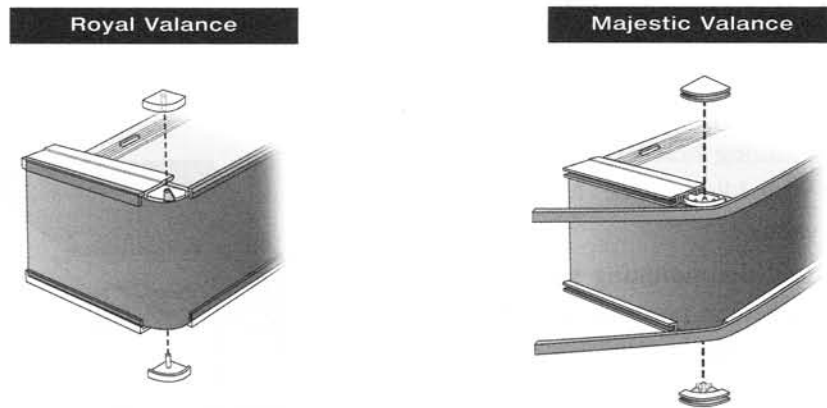

4. Only for Majestic valance: Secure the top and bottom colored trims by **pressing into** the grooves of the corners and of the valance returns. Trim off any excess using ordinary scissors.

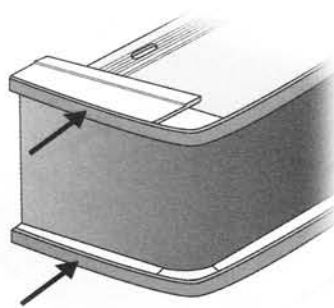

5. Only for Double Majestic Valance: Secure the returns of the lower section. **Slide** the two remaining lower section support brackets in position to secure the returns of the lower section (*Fig. B*).

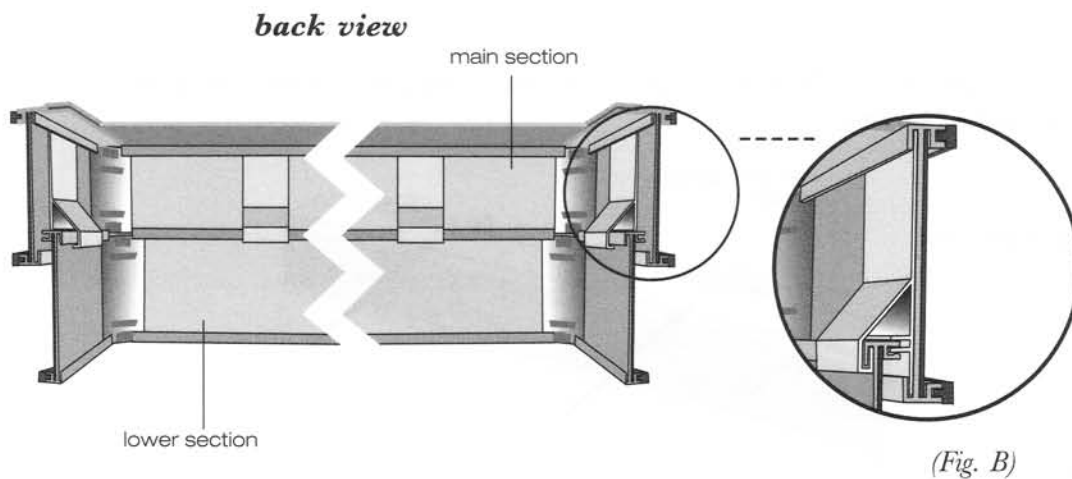

Mounting your valance (hardwares for a horizontal blind are illustrated)

Note: When necessary, the top of the valance can be trimmed down with a utility knife by scoring the back of it and snap the excess off.

Inside mount (blind/shade is mounted into the ceiling, or inside the window frame into the top of the frame)

Using regular brackets: Valance is screwed into the mounting surface **TOGETHER** with the mounting brackets

1. Determine position of the mounting brackets as instructed in the installation guide for your blind/shade. Match the position of brackets on the valance.
2. Drill holes into the valance and the mounting surface. Then place the mounting brackets in position and screw the valance into the mounting surface.

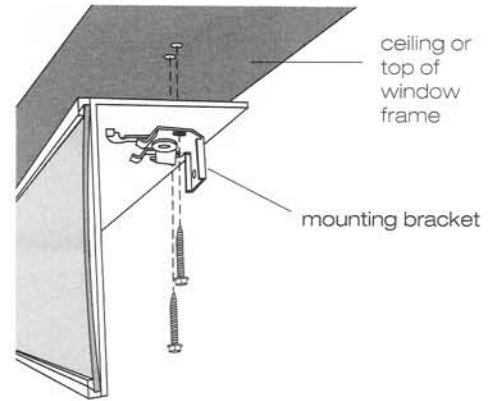

Using Box Brackets: Valance rests on headrail or track of blind

1. Cut the top of the valance to allow clearance for mounting brackets
2. Fit valance over headrail/track of blind/shade.

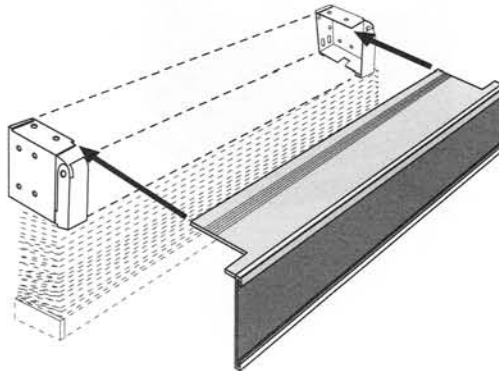

Outside mount (blind/shade is mounted on the window frame or wall)

Place completely assembled valance into the bracket lips of the valance support brackets and push in. The valance should rest on the brackets.

