

Before Starting

Your new blinds to go arch cellular shade is custom made to your specifications from the finest material available. The installation should be easy and shade should fit beautifully.

Mounting Options

Inside mount: Shade is mounted inside the window frame, either to the bottom of the frame or to the sides.

Outside mount: Shade is mounted either on or outside the window frame.

Note: Mounting screws provided are suitable for most mounting surfaces. Please see below for additional notes.

Suggested Tools

- » Drill
- » Level
- » Pencil
- » Screwdriver
- » Tape measure

For wallboard or plaster: Use hollow wall anchors for added support.

For concrete, stone, brick or tile: Use an appropriate drill bit and appropriate anchors before fastening the screws.

For metal surfaces: Pre-drill holes before fastening the screws.

Installing Arch Cellular Shade with Contour Headrail

If your shade comes with basic headrail, please proceed to page 4 "Installing arc cellular shade with basic headrail".

Parts



Regular bracket
 Quantity: 2 or more
 depending on size of shade



Mounting screw
 Quantity: 2 per bracket

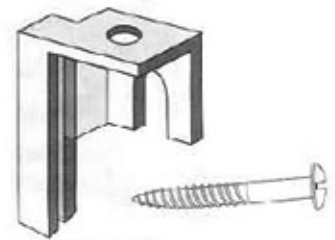

Support clip and screw
 Quantity: depending on size of shade

Optional Hardware (Only provided for specific application)

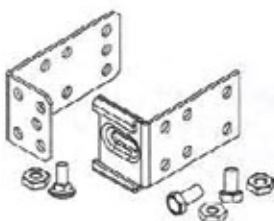

Projection bracket
 Quantity: 1 per regular bracket

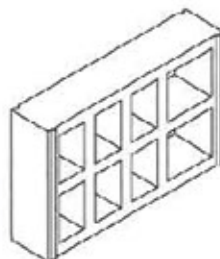

Spacer blocks
 Quantity: 1 per regular bracket

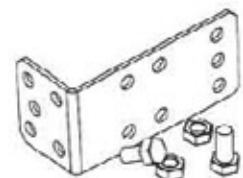

Side mount brackets
 Quantity: 2 sets

Getting Started

Step 1: Mounting Brackets

1. Hold the shade to where you want to mount it and mark approximately 2" in from each end of the headrail. This is here your brackets will go. We recommend you use a level to ensure bracket alignment.

When more than two brackets are supplied, position the additional brackets evenly between the two end brackets.

2. Mount the brackets as illustrated.

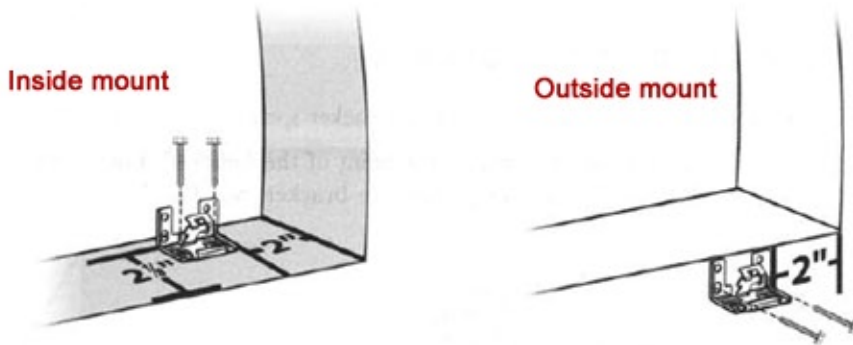

For the shade to be flush within the frame, the back edge of the brackets should be 2 1/8" back from the front of the frame.

Note: If you have ordered optional hardware, apply as illustrated.

applying spacer blocks (optional)

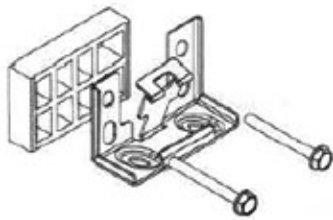

applying extension bracket (optional)

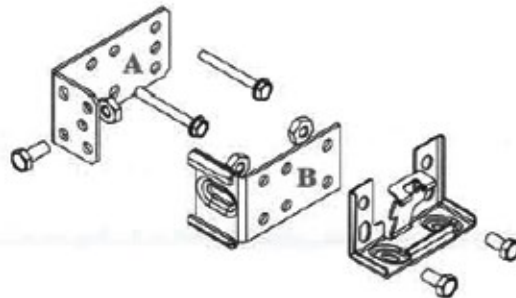

applying side mount bracket (optional)

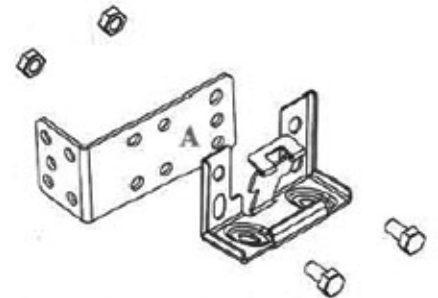

Bracket (A) can be turned around to accommodate different mounting situations.

Step 2: Assemble the Arch Shade

1. Remove the rubber bands and fan open the shade. Fig. A

2. Slide the fabric towards the opposite end of the headrail. Slide the base strip of the other half of the arch into the channel. Fig. B.

3. Insert the end cap into the headrail end until it snaps into place. Fig. C

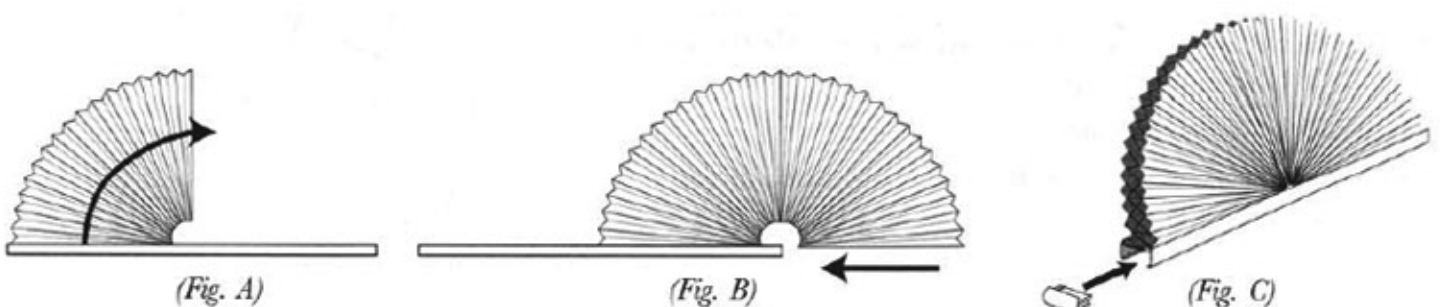

Step 3: Installing the Support Clips

1. Mark the locations for the support clips. Position the clips so that the back of the clips are the same depth as the back of the installation bracket.
2. Place a mark at the top center of the window.
3. Make sure that all marks are at a consistent depth within the sill.
4. Screw the arch support clips to the mounting surface through the hole in the top of the clip (inside mounts) or through the slot in the back (outside mounts).

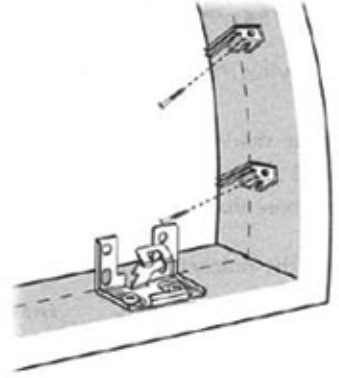

Step 4: Fitting the Shade into the Brackets

1. Hook the rear lip of the headrail on the mounting bracket spring tab. Fig. A
2. While pushing back against the bracket, rotate the front of the headrail downward to engage locking tab of mounting bracket. The shade will easily snap onto the bracket. Fig. B

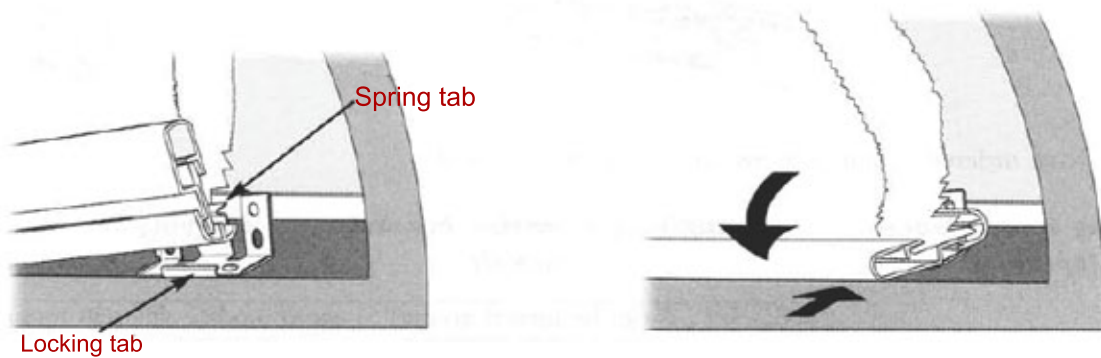

Note: To remove the shade, while pushing back on the shade to disengage locking tab of mounting brackets, rotate the front of the headrail up. Then remove the shade from the brackets.

Step 5: Place fabric into clips

1. Find the center of the fabric.
2. Gently press on the fabric until you are able to get the back cell into the top center support clip.
3. Next, go to the first clip up from the bottom of the arch, gently lift and fan out the fabric until the first section fits the window opening. Gently press on the fabric until you are able to get the back cell into the support clip.
4. Repeat for the remaining clips.
5. Check the fit of the arch shade. Reposition the fabric in the clips if necessary.

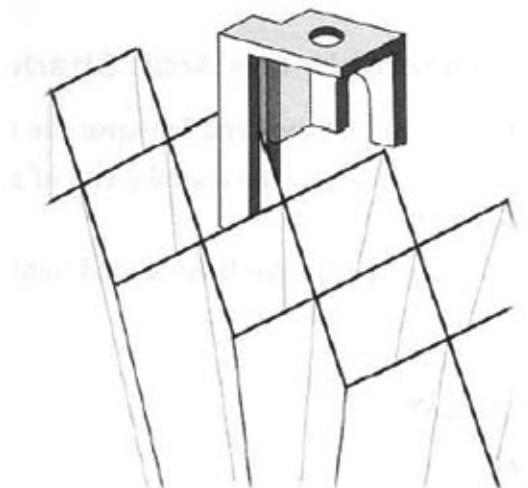

Installing Arch Cellular Shade with Basic Headrail

Parts

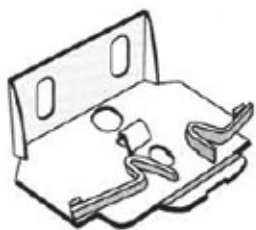

Regular bracket
Quantity: 2 or more, depending on size of shade



Mounting screws
Quantity: 2 per bracket

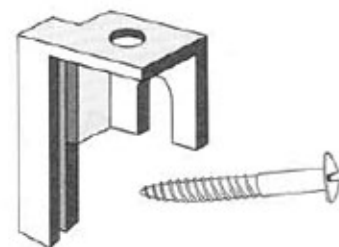

Support clip and screw
Quantity: depending on size of shade

Optional Hardware (Only provided for specific applications)

1. Hook the rear lip of the headrail on the mounting bracket spring tab. Fig. A
2. While pushing back against the bracket, rotate the front of the headrail downward to engage locking tab of mounting bracket. The shade will easily snap onto the bracket. Fig. B

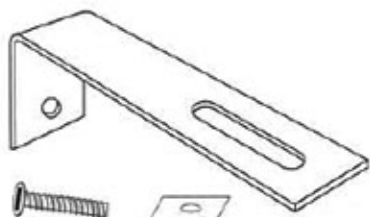

Projection bracket
Quantity: 1 per regular bracket

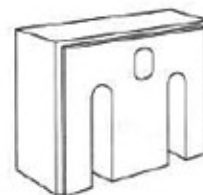

Spacer blocks
Quantity: 1 per regular bracket

Getting Started

Step 1: Mounting brackets

1. Hold the shade to where you want to mount it and mark approximately 3" in from each end of the headrail. This is where your brackets will go. We recommend you use a level to ensure bracket alignment. When more than two brackets are supplied position the additional brackets evenly between the two end brackets.
2. Mount the brackets as illustrated.

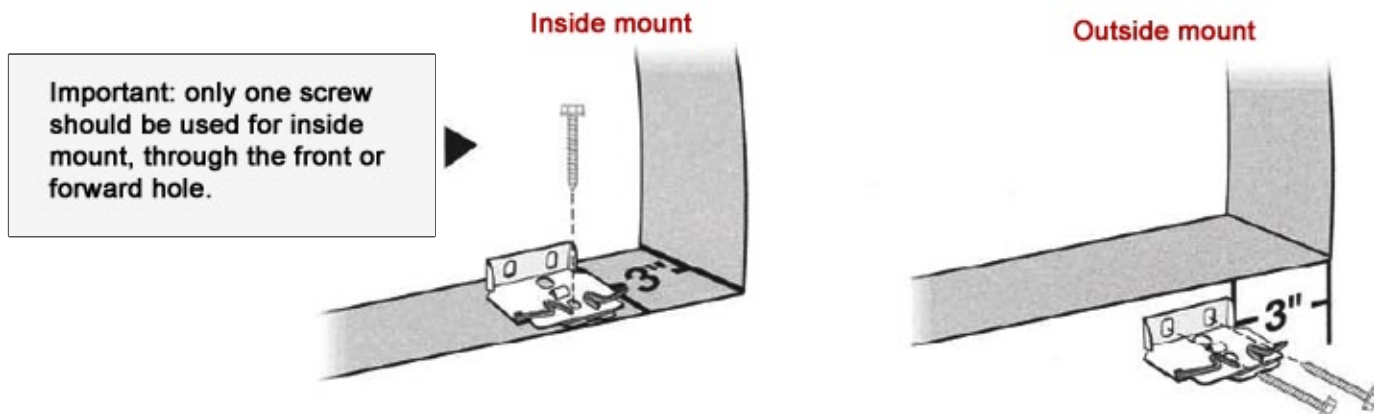

Note: If you have ordered optional hardware, apply as illustrated.

applying spacer blocks
(optional)

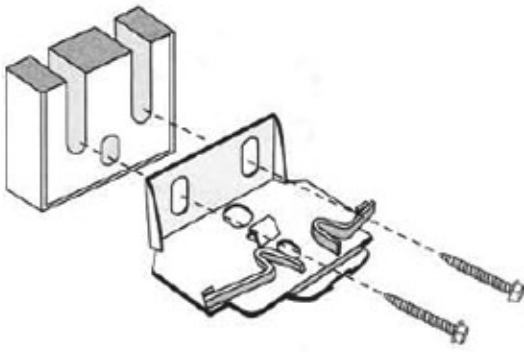

applying extension bracket
(optional)

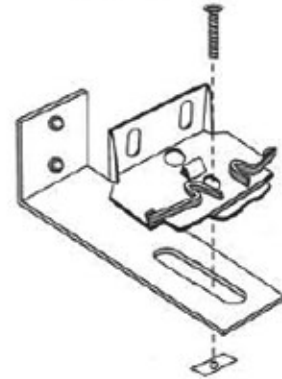

Step 2: Assemble the Arch Shades (see page 2)

Step 3: Installing the plastic clips (see page 3)

Step 4: Fitting the shade into the brackets

Place the front of the metal bracket into the inside front groove of the headrail. Then push headrail backwards firmly (Fig. A) and it will snap into the bracket (Fig. B)

Side View

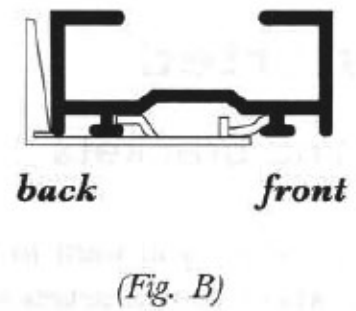
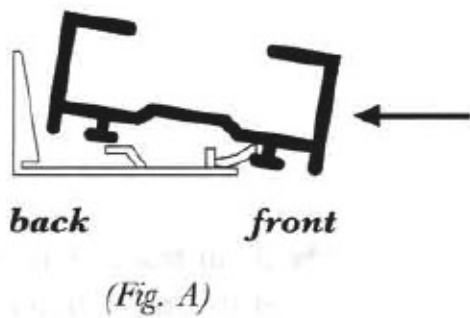

Step 5: Place fabric into clips (see page 3)